

INTERIOR DESIGN SPEAKER SYSTEM

H-3/H-3WP

2-Way Wall-Mount Speaker System



DESCRIPTION

THE H-3 TWO-WAY WALL-MOUNT SPEAKER featuring wide horizontal dispersion. The H-3's unique appearance and superb sound quality provide a welcome alternative to conventional wall-mount speakers for spaces where appearance is a prime consideration.

Applications include speaker systems for hotels, houses of worship, offices, museums, residential spaces, restaurants, retail stores, and many others. A weather-resistant version, model H-3WP, is also available for outdoor applications such as gardens, patios and swimming pools.

The H-3's wide 140 degree horizontal coverage pattern provides a solution for eliminating deadspots inherent between wall-mounted speakers. Also, the Minimum Reflection design significantly reduces sound wave reflections and the resulting sound coloration that occurs with conventional bracket-mounted "box" type speakers.

The H-3 is a two-way, sealed enclosure with high quality components including a 2.5 cm dome tweeter, dual 10 cm woofers, matching transformer, and removable terminal block. The grille is paintable for custom-matching to the room decor.

SPEAKER SOUND DISPERSION CHARACTERISTICS

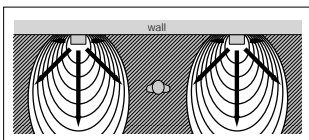

Conventional speaker dispersion patterns leave dead areas between speakers.

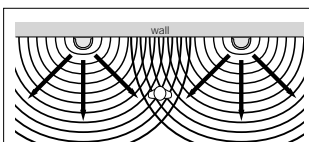

H Series speakers create optimum dispersion between speakers as well as in front of the speakers.

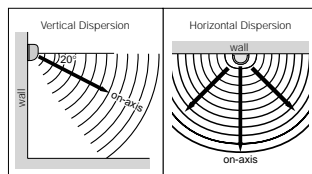

Area covered by speaker.

FEATURES

- Unique appearance blends well with modern architecture for background/ foreground music and paging systems.
- Two-way, sealed enclosure with high-quality components: 2.5 cm dome tweeter and dual 10 cm woofers both equipped with neodymium magnets.
- Wide Variety of Applications including hotels, houses of worship, museums, offices, residential spaces, restaurants, and retail stores.
- Built-in 70/100 V matching transformer (30 W max.) for distributed speaker systems.
- Wide coverage area: 140° horizontal x 70° vertical dispersion.
- Protection circuit prevents loudspeaker damage from excessive input.
- Weather-resistant version available, model H-3WP, for outdoor applications such as gardens, patios and swimming pools.
- Built-in crossover with optimized filter slopes.
- UL-listed fire-resistant material.
- Minimum reflection design reduces sound wave reflections typical of conventional bracket-mounted "box" type speakers.
- High power handling: 150 W (Continuous Program)
- Removable terminal block with loop-through terminations for distributed speaker systems to custom-match to the environment.
- Paintable grille to custom-match to the environment.

H-3/H-3WP

Direct, Reflected and Summed Response

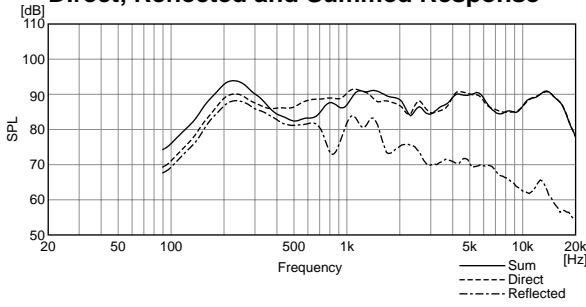

Horizontal (0° - 60°)

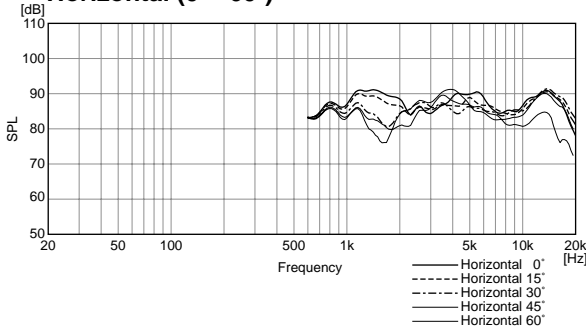

Beamwidth vs Frequency

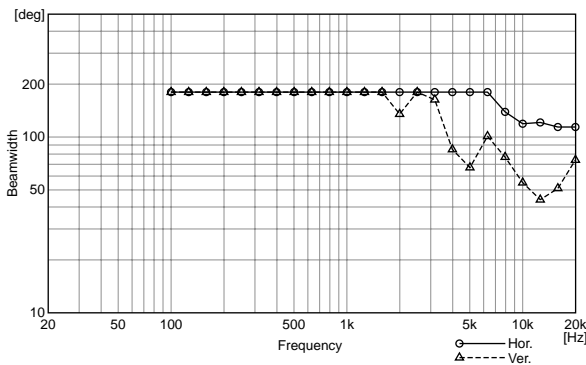

Directivity Factor vs Frequency

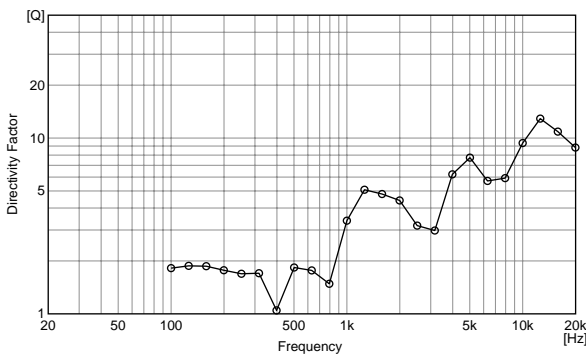

Frequency Response when using a Digital Signal Processor

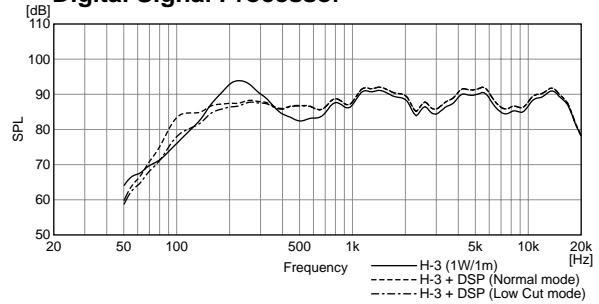

Recommended Filtering by a Digital Signal Processor

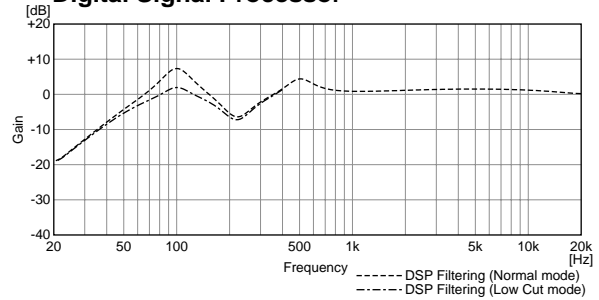

Normal mode (when not using a subwoofer)

Filter	Frequency	Gain	Q
HPF	63 Hz	—	0.707
PEQ	100 Hz	+9 dB	2.871
PEQ	220 Hz	-8 dB	2.871
PEQ	500 Hz	+5 dB	2.871
PEQ	5,000 Hz	+1.5 dB	0.305

Low Cut mode (when using a subwoofer)

Filter	Frequency	Gain	Q
HPF	63 Hz	—	0.707
PEQ	100 Hz	+5 dB	2.871
PEQ	220 Hz	-8 dB	2.871
PEQ	500 Hz	+5 dB	2.871
PEQ	5,000 Hz	+1.5 dB	0.305

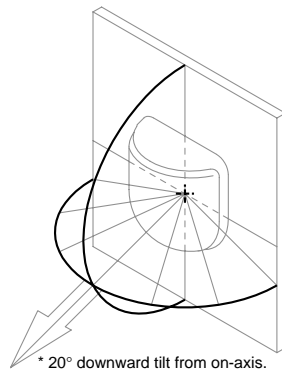

CHARACTERISTIC DIAGRAMS

Polar Response

horizontal

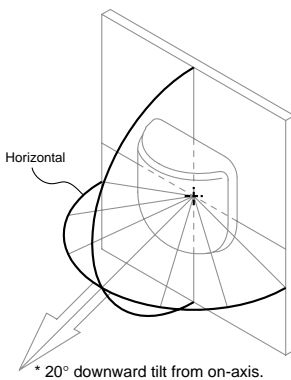
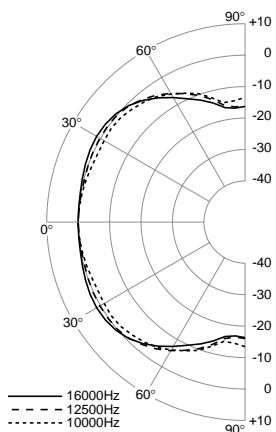
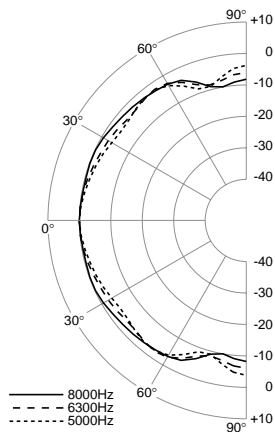
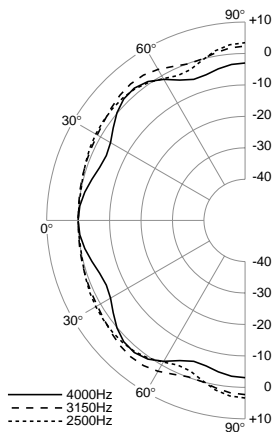
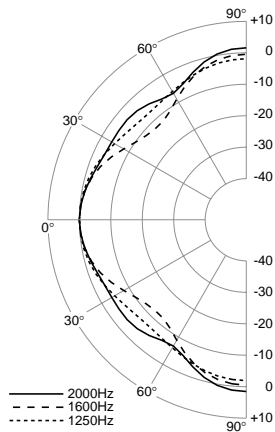
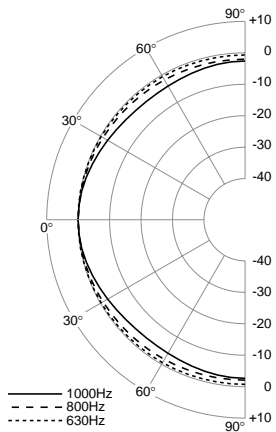
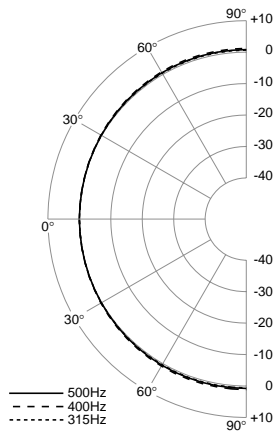
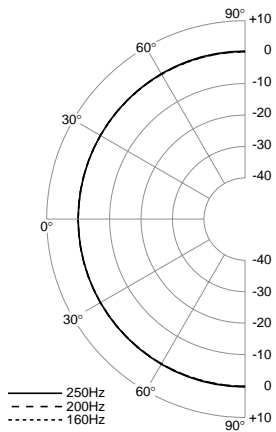

vertical

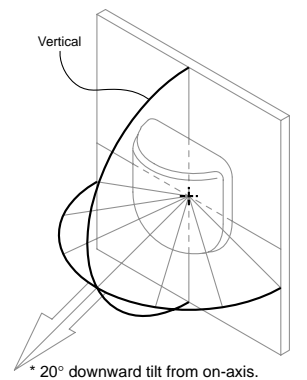
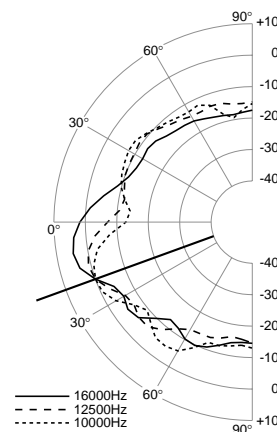
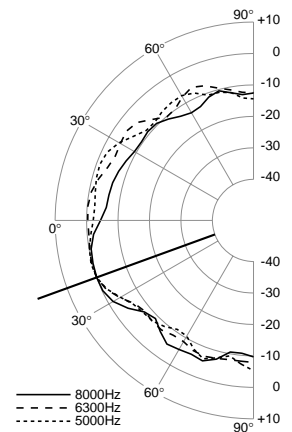
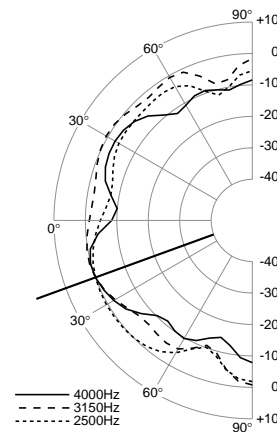
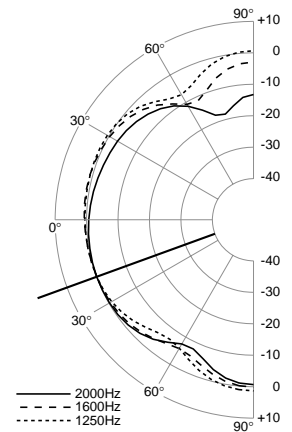
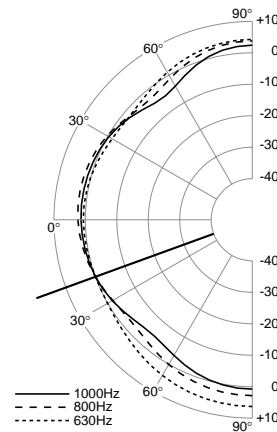
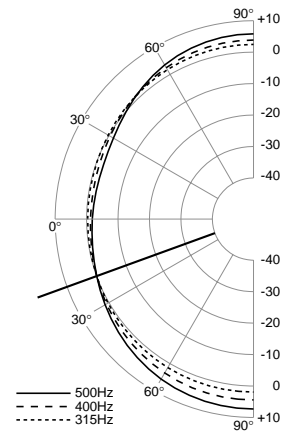
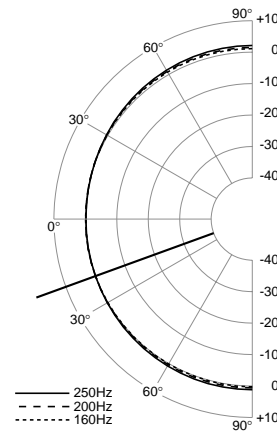

SPECIFICATIONS

	H-3/H-3WP
Enclosure	Sealed
Power Handling	150W (continuous program/8Ω), 50W (continuous pink noise/8Ω, 50 – 20,000Hz)
Rated Input	30W (16Ω, 70V/100V line)
Impedance	Direct: 8Ω. Transformer: 16Ω 100V line: 330Ω (30W), 670Ω (15W), 1.3kΩ (7.5W) 70V line: 170Ω (30W), 330Ω (15W), 670Ω (7.5W), 1.3kΩ (3.75W)
Sensitivity	89dB (1W/1m, 1/2 space)
Frequency Response	100 – 20,000Hz (–10dB, 1/2 space)
Crossover Frequency	4,000Hz LPF: –12dB/octave HPF: –18dB/octave
Water Resistance	IP-X4 (H-3WP)
Speaker Components	10cm cone woofer (neodymium magnet) x 2 2.5cm dome tweeter (neodymium magnet)
Input Connector	Removable terminal block with screw terminals (AWG #14 – #24), 2 pairs of (+)/(-) for input and loop-through terminations
Material/Finish	Enclosure; fire-resistant ABS resin (UL94;V-0 grade), black Grille; H-3 ; steel plate,white, paint H-3WP ; steel plate (zinc plating),white, paint Grille frame; fire-resistant ABS resin (UL94; V-0 grade), white, paint Base plate; H-3 ; steel plate, plating H-3WP ; stainless steel
Dimensions	295 (W) x 318 (H) x 129 (D) mm
Weight	3.3kg (including base plate)
Accessories	Front grille x 1 Base plate x 1

APPEARANCE AND DIMENSIONAL DIAGRAMS

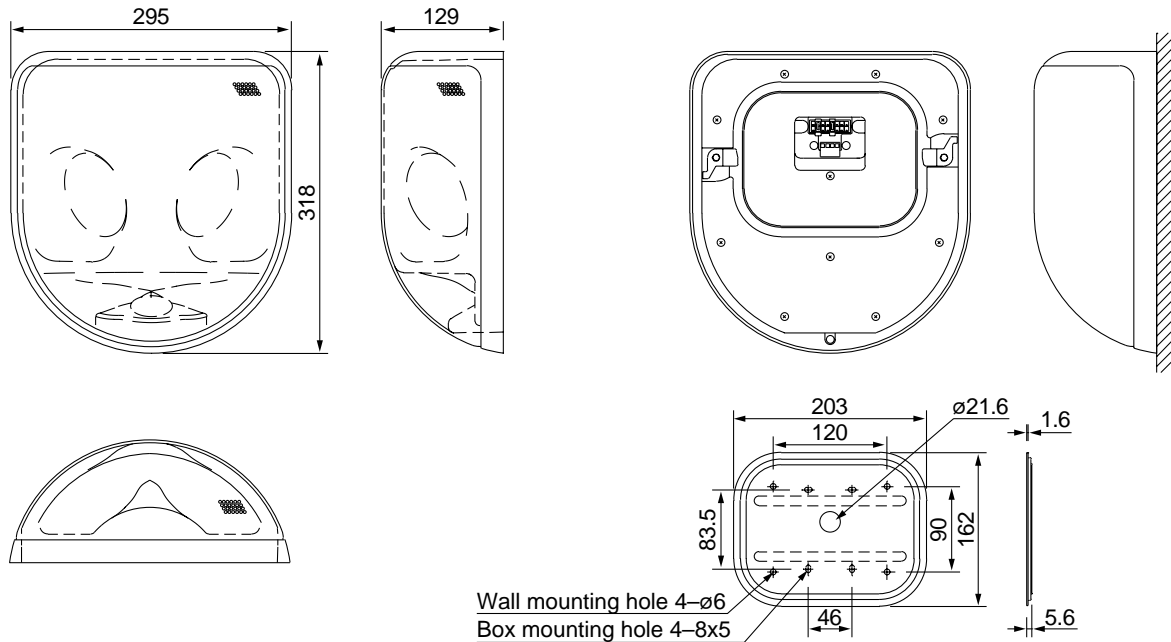

Unit: mm