



PE-304BU/304WU/604BU/604WU Pendant Speaker



DESCRIPTION

The PE-304BU, PE-304WU, PE-604BU and PE-604WU are HIPS resin bass-reflex enclosure with a 12cm (5") cone-type woofer and a balanced-dome tweeter. These pendant speakers are intended to be installed suspended from a ceiling. They are very lightweight, with a stylish design inspired by modern lighting fixtures, allowing them to harmoniously blend in with a room design. These speakers are ideally suited for applications such as Background Music (BGM) and announcements in high-ceiling venues such as airports, factories and shopping malls, and, in addition, certification to UL 1480 UUMW (Mass Notification System) and ULC-S541 standards enables them to work in emergency announcement systems. The speakers can be driven on both high-impedance (100V, 70V and 25V) and low-impedance (8Ω) lines. Input impedance is adjustable with a rotary switch on the top of the speaker. The hanging wire, safety wire and speaker cable are pre-attached, for quick and easy installation. GRIPPLE® hangers facilitate speaker mounting height adjustment.

*GRIPPLE® is a registered trademark of Gripple Limited, England.

FEATURES

- Remarkably lightweight and stylish design inspired by modern lighting fixtures (PE-304BU/WU: 2.0kg (4.41lb) & PE-604BU/WU: 2.9kg (6.39lb) (unit only))
- Coaxial bass-reflex design featuring a 12cm (5") cone-type woofer and a balanced-dome tweeter
- 8Ω and 25V/70V/100V operation
- Input impedance is easily changed with a rotary switch on the top of the speaker.
- UL 1480 UUMW and ULC-S541 listed. Certified to work with emergency announcement systems
- Speaker comes with speaker cable, GRIPPLE® hanging wire and safety wire pre-attached, for faster, easier and more secure installation.
- Ideally suited for BGM and announcements
- Available in black or white finish



PE-304BU/304WU/604BU/604WU Pendant Speaker

SPECIFICATIONS

Model No.	PE-304BU/304WU	PE-604BU/604WU
Enclosure:	Bass-reflex type	
Rated Input	30W (100V, 70V line, 8Ω), 3.7W (25V line)	60W (100V, 70V line, 8Ω), 7.5W (25V line)
Rated Impedance	100V line: 330Ω (30W), 1kΩ (10W), 3.3kΩ (3W), 10kΩ (1.3W) 70V line: 170Ω (30W), 330Ω (15W), 1kΩ (5W), 3.3kΩ (1.5W), 10kΩ (0.6W) 25V line: 170Ω (3.7W), 330Ω (1.9W), 1kΩ (0.6W), 3.3kΩ (0.2W), 10kΩ (0.1W) Low impedance: 8Ω	100V line: 170Ω (60W), 330Ω (30W), 670Ω (15W), 3.3kΩ (3W) 70V line: 83Ω (60W), 170Ω (30W), 330Ω (15W), 670Ω (7.5W), 3.3kΩ (1.5W) 25V line: 83Ω (7.5W), 170Ω (3.7W), 330Ω (1.9W), 670Ω (0.9W), 3.3kΩ (0.2W) Low impedance: 8Ω
Sensitivity (1W, 1m)	90dB (330Hz – 3.3kHz, pink noise)	
Frequency Response	95Hz – 20kHz (–10dB)	110Hz – 20kHz (–10dB)
Speaker Component	12cm (5") cone-type + balanced-dome tweeter (coaxial)	
UL Code	UL1480 UUMW, ULC-S541	
Operating Temperature	–10°C to +50°C (14°F to 122°F)	
Finish	PE-304BU: Enclosure: HIPS resin, black Grille: Surface-treated steel plate mesh, black, paint PE-304WU: Enclosure: HIPS resin, white (RAL 9010 equivalent) Grille: Surface-treated steel plate mesh, white (RAL 9010 equivalent), paint	PE-604BU: Enclosure: HIPS resin, black Grille: Surface-treated steel plate mesh, black, paint PE-604WU: Enclosure: HIPS resin, white (RAL 9010 equivalent) Grille: Surface-treated steel plate mesh, white (RAL 9010 equivalent), paint
Dimensions	ø186 x 275 (H) mm (ø7.32" x 10.83") (Not including wires and cable)	
Weight	2kg (4.41 lb) (Not including wires and cable)	2.9kg (6.39 lb) (Not including wires and cable)
Accessory	GRIPPLE® No. 1 x 1, GRIPPLE® No. 2 x 1, Release key (for GRIPPLE®) x 1, Safety wire (ø1.5mm (ø0.06")) x 1, Hanging wire (ø2mm (ø0.08")) x 1, Speaker Cable (4-core FPL listed cable 4.6m (15.09ft)) x 1	

*GRIPPLE® No. 1 and GRIPPLE® No. 2 are hangers for suspending the speaker.
*GRIPPLE® is a registered trademark of Gripple Limited, England.

APPEARANCE AND DIMENSIONAL DIAGRAM

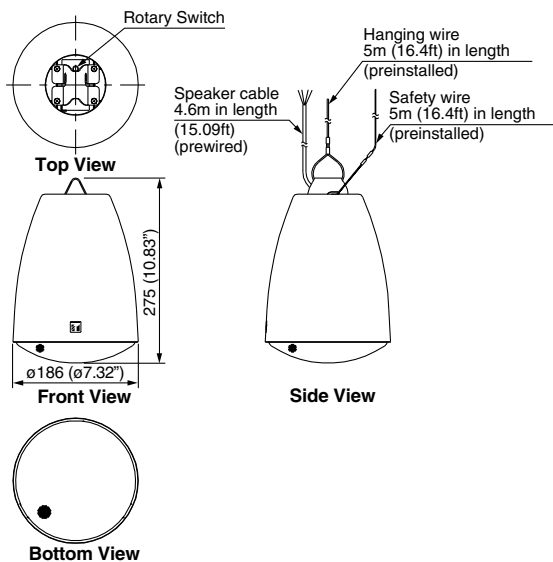

Wiring Diagram

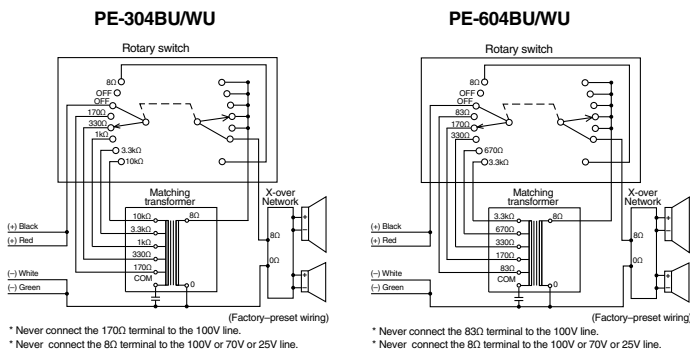

Architect's and Engineer's Specifications

PE-304BU/WU

The speaker shall be a bass-reflex design with a 12cm (5") cone-type woofer and a balanced-dome tweeter, suitable for ceiling suspension mounting. Input impedance shall be easily adjustable with a rotary switch on the top of the speaker.

The speaker shall include a transformer having multiple taps of 1.3W, 3W, 10W, 30W at 100V, 0.6W, 1.5W, 5W, 15W, 30W at 70V, and 0.1W, 0.2W, 0.6W, 1.9W, 3.7W at 25V and 8Ω. The sensitivity at a distance of 1m with a 1W input level applied shall be 90dB SPL. The speaker shall have a frequency response of 95Hz – 20kHz (–10dB).

The speaker enclosure shall be constructed of HIPS resin. The grille shall be constructed of surface-treated steel plate mesh. The speaker shall be available in black (PE-304BU) or white (PE-304WU) color. The unit shall have dimensions of ø186 x 275 (H)mm (ø7.32" x 10.83"), and a weight of 2kg (4.41lb). The speaker shall be provided with speaker cable, GRIPPLE® hanging wire and safety wire already attached.

The speaker shall be certified to UL 1480 UUMW and ULC-S541 standards.

The speaker shall be a TOA model PE-304BU or PE-304WU.

PE-604BU/WU

The speaker shall be a bass-reflex design with a 12cm (5") cone-type woofer and a balanced-dome tweeter, suitable for ceiling suspension mounting. Input impedance shall be easily adjustable with a rotary switch on the top of the speaker.

The speaker shall include a transformer having multiple taps of 3W, 15W, 30W, 60W at 100V, 1.5W, 7.5W, 15W, 30W, 60W at 70V, and 0.2W, 0.9W, 1.9W, 3.7W, 7.5W at 25V and 8Ω. The sensitivity at a distance of 1m with a 1W input level applied shall be 90dB SPL. The speaker shall have a frequency response of 110Hz – 20kHz (–10dB).

The speaker enclosure shall be constructed of HIPS resin. The grille shall be constructed of surface-treated steel plate mesh. The speaker shall be available in black (PE-604BU) or white (PE-604WU) color. The unit shall have dimensions of ø186 x 275 (H)mm (ø7.32" x 10.83"), and a weight of 2.9kg (6.39lb). The speaker shall be provided with speaker cable, GRIPPLE® hanging wire and safety wire already attached.

The speaker shall be certified to UL 1480 UUMW and ULC-S541 standards.

The speaker shall be a TOA model PE-604BU or PE-604WU.



PE-304BU/304WU/604BU/604WU Pendant Speaker

CHARACTERISTIC DIAGRAMS

PE-304BU/WU

Polar Response

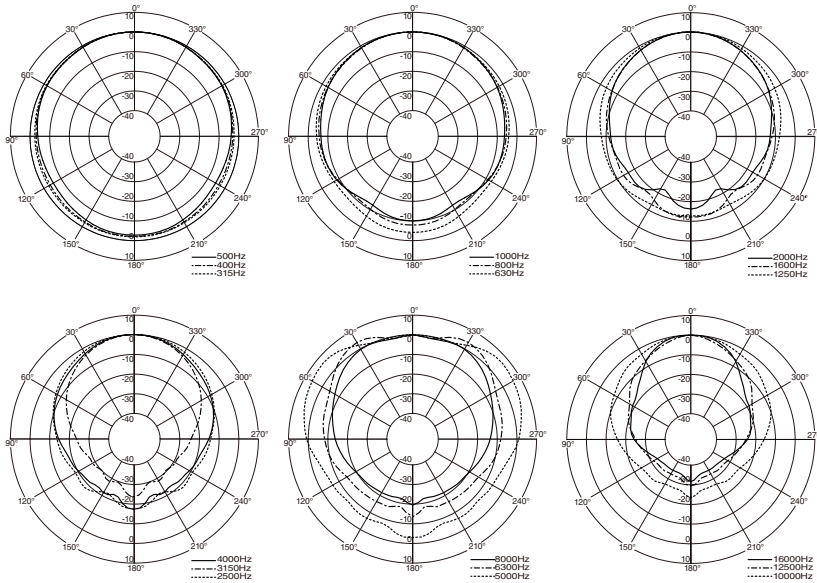

SPL vs. Frequency

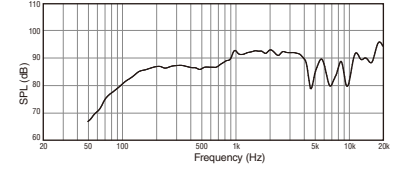

Beamwidth vs. Frequency

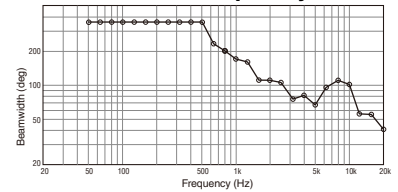

Directivity Factor vs. Frequency

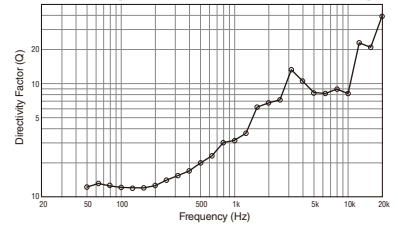

PE-604BU/WU

Polar Response

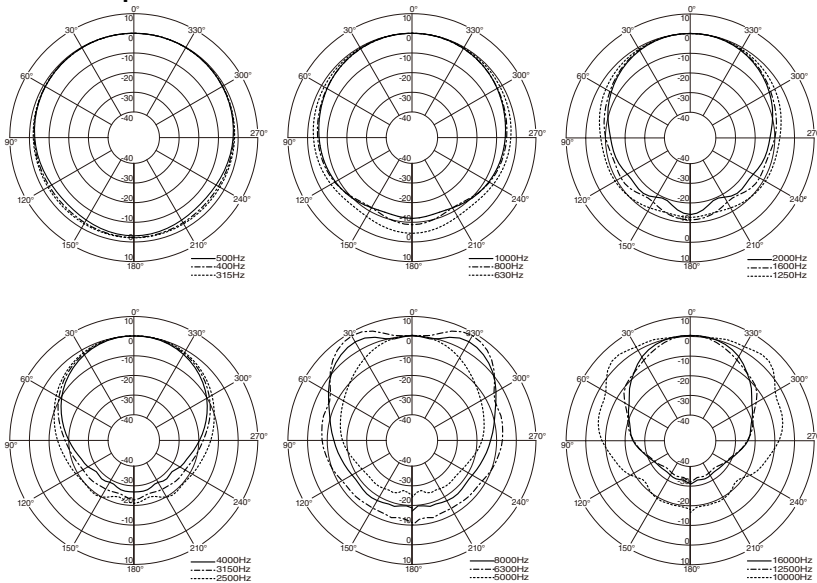

SPL vs. Frequency

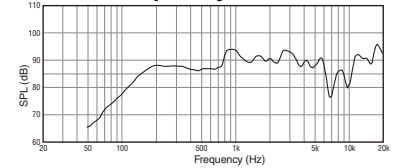

Beamwidth vs. Frequency

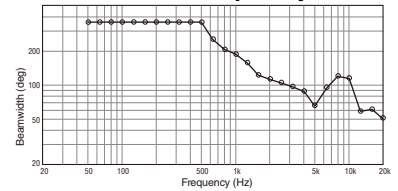

Directivity Factor vs. Frequency

